

POWERSTAR Garbage Compactor Truck

User's Manual



POWERSTAR TRUCKS INDUSTRY CO., LIMITED

<http://www.isuzutruckscn.com/>

Preface

Thank you for purchasing POWERSTAR TRUCKS products. For better using your ISUZU 6Tons garbage compactor truck, get the best operating performance, we strongly suggest that before the operation process you could read this manual instructions carefully, and to manipulate the program handily.

The manual detailed describes the performance of garbage compactor truck, structure, usage, precautions and maintenance of such knowledge. While showing details of the truck, both pictures and description will together help you get better understanding of how to use truck. Before the operation, the skilled operator should carefully read the contents of the manual.

After master the truck performance characteristics, methods of operation and precautions, then could start to operate this garbage truck. In order to ensure the staff turnover after the operation, and properly use of the truck. This manual book must be properly kept, shall not be lost and damage.

CEEC TRUCKS

----POWERSTAR TRUCKS

Contents

Chapter 1. General Description	4
Chapter 2, Main Technical Data.....	5
Chapter 3, Garbage Compactor Truck Structure Components	6
1, Product Overview.....	6
2. Introduction of Hydraulic System	8
3. Brief Introduction of Air Circuit System	9
4. Brief Description of Electrical System	10
Chapter 4, Garbage Compactor Truck Working Principles	15
i ,How are the Garbage Compactor trucks working?	15
ii ,What is the main component for truck?	15
iii, How to operate garbage compactor trucks? (Very Important)	16
Chapter 5, Maintenance and Repair Instruction	27
Chapter 6, Troubleshooting	31

Chapter 1. General Description

POWERSTAR TRUCKS Garbage Compactor Truck based on Customized ISUZU 700P ELF 4x2 model LHD chassis, Compactor body capacity could up to 6tons , which equipped with CAN Electric Control System and Hydraulic Joystick Control System, mainly used for garbage collection and transportation, and the working aerial can be city street, factory, community and other areas of need.

The vehicle designed to fully rely on the advantages of the original of ISUZU brand chassis, fully consider the product's convenience and reliability, also the chassis technology features. The garbage compactor body material is international standard high strength carbon steel, both internal and external with anti-rust painting, which can effective to avoid rusting. As for compactor body capacity is 6Tons and safety enough to collecting & transporting waste on customer requirement.

The 4x2 Garbage Compactor Truck equipped with new designed CAN control system, multi-function garbage compression system, side climbing ladder, Electric control boxes in cabin and rear of hopper, rear part installed foot pedal, which is customized to collect garbage from different area, two units waste water collection tank can efficiently prevent second pollution during transportation. Cab for the single-row Comfortable seat, nice driving feeling. Therefore, the vehicle is an ideal Fuel Tanker Truck mainly for oil transportation & refueling function.



(Preview for your ISUZU 6TONS Garbage Compactor Truck)

Chapter 2, Main Technical Data

Basic parameter:

Items		ISUZU ELF 6Tons Garbage Compactor Truck
S I Z E	Outer Dimension (L×W×H) (mm)	8000x2300x2650
	Wheelbase (mm)	4175
Kerb Weight (kg)		7,000
G E A R	Gearbox brand	ISUZU
	Model	MLD
	Type	6-shift Manual
Cab capacity (includes driver)		2
E N G I N	Brand	ISUZU
	Model	4HK1-TC51
	Type	Diesel
	Rating Power (kW/HP)	140KW / 190HP

Note: 1. We keeps the right to revise the parameters on the list above.

Garbage Body basic parameter list

Items		Parameter	
G a r b a g e B o d y	Capacity (TONS)	6	
	Material	Standard Carbon Steel	
	Painting	Internal	With anti-rust painting
		External	Gray painting as required
	Control System	Electric Control	Control Box in Cabin
		Hydraulic Control	Control Box two sides of hopper
	PLC	Behind of cabin at driver side	
	Hydraulic Cylinder quantity	PLC	New designed CAN System
		Hopper	2
		Slide Plate	2
Scraper		2	
Tilting Device		2	
Push Plate	1		

Chapter 3, Garbage Compactor Truck Structure Components

1, Product Overview

This Compressed Garbage Truck is a new generation of products independently developed and designed by POWERSTAR TRUCKS INDUSTRY CO., LIMITED. Based on the similar products features and advantages of in domestic and abroad market, which is beautiful in appearance, excellent in performance and advanced in operation and control. The collection and transportation of urban domestic waste can be achieved by using the back-loaded compaction and bi-axial compression technology. Its comprehensive performance reaches the advanced level of domestic similar products.

1.1.1 Main performance and characteristics

- a. Elegant appearance, the main components made of high-quality high-strength manganese steel, sound structure, strong rigidity and high strength.*
- b. Powerful loading capacity, apply the bi-axial compression technology, the volume of domestic waste can be up to 600~800Kg/m³ after compression.*
- c. Combined electric-air-liquid control, utilize the advantages of electronic control, gas control and hydraulic control to control and convert the energy, thus ensuring the accurate and reliable operation of each mechanism, and improving the reliability and efficiency of operation.*
- d. The electronic control system adopts the electrical components produced by well-known domestic and foreign manufacturers, and CAN-BUS integrated control is adopted to reduce the failure rate and prevent accidents caused by misoperation.*
- e. Convenient operation control, the operation control box is respectively installed in the cab and the rear, the operation control box in the cab can be used to control the pushing and unloading and select the operation mode, the operation control box on the right side of the rear can be used to control the operation of the compressing-filling mechanism and the bucket-lifting mechanism, which is quite convenient; especially for working in the landfill, the operator can unload garbage without getting off.*
- f. Pneumatic control is adopted to open and close the pre-compressor cover, with elegant and simple appearance and friendly operation.*
- g. During the compression, filling and transportation, the garbage shall be under closed state, and unique technology of "sealing" and "dredging" is adopted to greatly reduce the dripping and*

spraying of sewage in the process of collection and transportation.

1.1.2 Applicable scope

This product is mainly used for collecting and transporting domestic waste in cans, in bags and in bulk from urban roads, urban residential areas, communities, large-scale factories and mines, etc.

This truck is not suitable for collecting and transporting construction waste, industrial waste and kitchen waste.

1.1.3 Working conditions

POWERSTAR Compressed Garbage Truck shall work on flat and hard ground under the ambient temperature between $-20\text{ }^{\circ}\text{C} \sim 50\text{ }^{\circ}\text{C}$.

1.1.4 Product nameplate/safety marks and location

The nameplate is located on the right side of the longitudinal beam at the front end of the garbage can of this truck.

The position of security marks is shown as below.

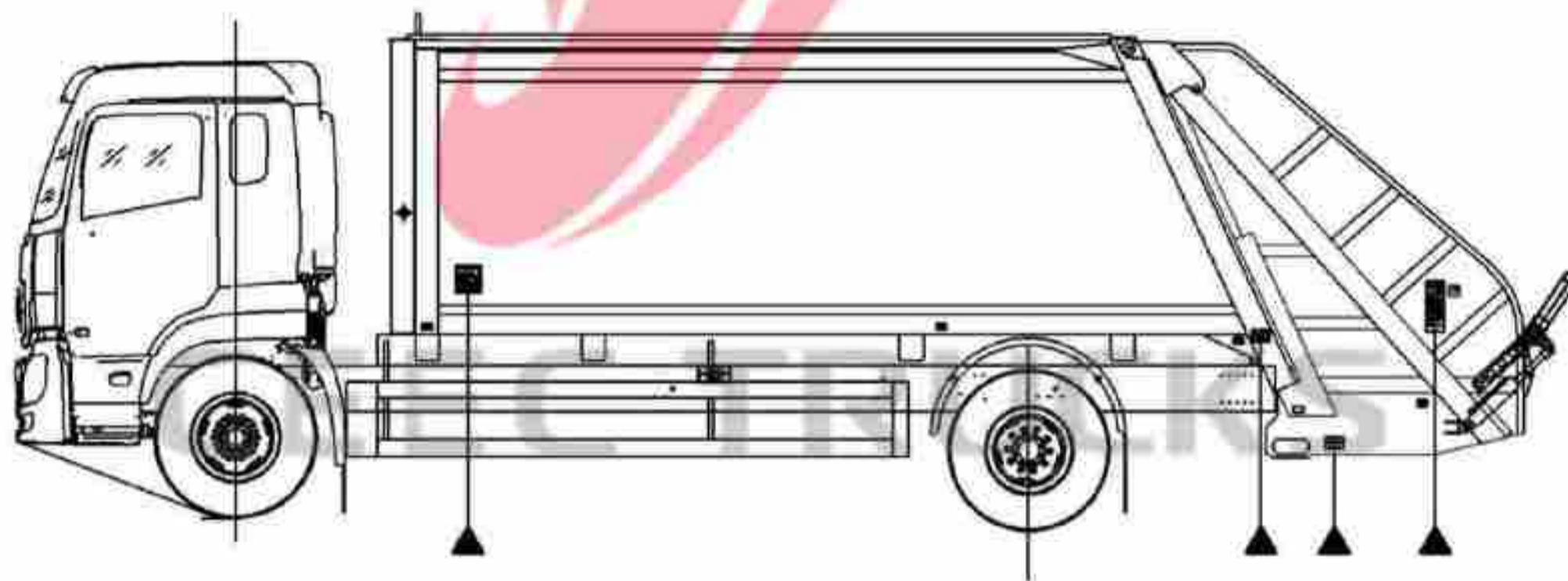

Position Map of Safety Marks

1.1.5 Side protection devices

The side protection device is made of Q235 material, and connected with the vehicle with bolts. GB/11567 Motor Vehicles and Trailers-Lateral and Rear Under run Protection Requirements shall be applied.

1.1.6 Other requirements for products specified in GB 7258

Please refer to Table and chassis instruction manual for overall dimensions, quality parameters, main engine technical parameters and others specified in GB 7258.

2. Introduction of Hydraulic System

The hydraulic system of POWERSTAR TRUCKS Garbage Compactor Truck is an open-type system that supplied by a gear pump, and the gear pump is powered through the engine, transmission, and power take-off (PTO). The PTO is equipped with electrically controlled gas-operated clutch, which can be accomplished by controlling the manual valve in the cab. The outlet opening and return opening of fuel tank are respectively installed with rough and refined oil filter to keep the working fuel pumped to the hydraulic system clean. After the high-pressure fuel supplied by the fuel pump enters the multiple directional control valves, the operator shall control the multi-channel valve, and distribute the high-pressure fuel to corresponding circuit to drive the corresponding mechanism to move. The operator shall control the electromagnetic valve through the CAN bus controller or button by following the operation procedure, and drive the cylinder to control the multi-channel valve to complete the garbage compressing-filling cycle or discharging garbage or dumping the garbage can (bucket) and so on. The multi-channel valve is installed with a built-in relief valve (safety valve) to prevent system from overloading. When the valve element of the multi-channel valve is in the middle position, the system is in the unloading state. The accessory valve at the fuel openings of the multi-channel valve serves a corresponding role of unloading or replenishing fuel. The setting pressure of the push-shovel valve can push the slider cylinder to reach a certain working pressure to compress the garbage, and then the push-shovel cylinder can get back to the original point. The cylinder in the lifting circuit is set with a balance valve, which can ensure that the pre-compressor can fall down smoothly and stay in any position for a long time, and ensure that the pre-compressor will not drop suddenly when the pipeline of the lift cylinder cracks and can remain safe to use.

2.1 Pressure setting of each pressure valve

1. To prevent system overload and return circuit of large and small pumps in the system, two relief valves have been installed respectively, with the setting pressure of 18 MPa.
2. Push-shovel valve pressure is 12 MPa, and push-shovel overload valve pressure is 12 MPa.

The pressure of relief valve and overload valve has been well set when the product leaves the factory. It is forbidden for non-professional maintenance personnel to adjust.

2.2 Operation of hydraulic system and precautions

1. The hydraulic cylinder movement of all movement mechanisms of the truck is controlled by the air-controlled multiple directional control valve, with the movement indicators affixed to accessories of multiple directional control valve, and corresponding to respective location;

2. The multiple directional control valves can be controlled automatically or manually. The automatic mode refers to achieving the function of extending and retracting the hydraulic cylinder by the right cylinder of the multi-channel valve pushing the multiple directional control valve; while the manual mode refers to pushing the multiple directional control valve to achieve the function of extending and retracting the hydraulic cylinder by inserting the handle level (screwdriver) into the left handle of the multi-channel valve;

3. Under normal operation, the automatic mode is available, and the operator can press the button the switch the extending or retracting of cylinder to achieve the corresponding function. Manual mode can be used only when the equipment electrical system or hydraulic system breaks down and needs to be maintained;

4. Before operating the hydraulic system, according to the operating requirements of PTO (power take off), PTO shall be in gear.

2.3 Pressure detection on hydraulic system

The multi-channel valve group is equipped with the pressure gauge to detect the pressure value of each pressure point in the system.

Fuel pressure shall be tested and adjusted when the engine is at idle state or working state and the hydraulic fuel pump shall be in the working condition.

3. Brief Introduction of Air Circuit System

This truck's air circuit system mainly plays the following three roles:

- a. Turn on and turn off PTO;
- b. Invert the electromagnetic valve through the cylinder to achieve the corresponding functions;
- c. Open or close pre-compressor cover (this function is optional only for vehicles equipped with bucket-tilting mechanism as the feeding mechanism).

4. Brief Description of Electrical System

This system is a control device specially designed for loading and unloading garbage.

The operator can, by virtue of the push-button switch (mounted on the cab and the pre-compressor) and the proximity switch (mounted on the slider, which can check if the stroke at the upper part and bottom part of the slider is in place, if the scraper opens and closes in place), input the command signal into the CAN bus controller via encoding, and then drive the output by the program that has been coded in the controller according to the operation requirements of the garbage truck, which can actuate the corresponding executive element-the electromagnetic valve to act and realize the operation control of garbage truck operation device.

This system, installed with imported high-quality electrical components, is programmed with a variety of control procedures for selection before delivery. The operator can check the input and output via input and output indicators on the programmable controller. And Step-down processing technology has been applied in the power circuit, which can adjust the power input range to 24-30 VDC. As a result, the system is featured with high reliability, simple operation, easy maintenance and other characteristics.

Overview for garbage compactor truck technical drawing:

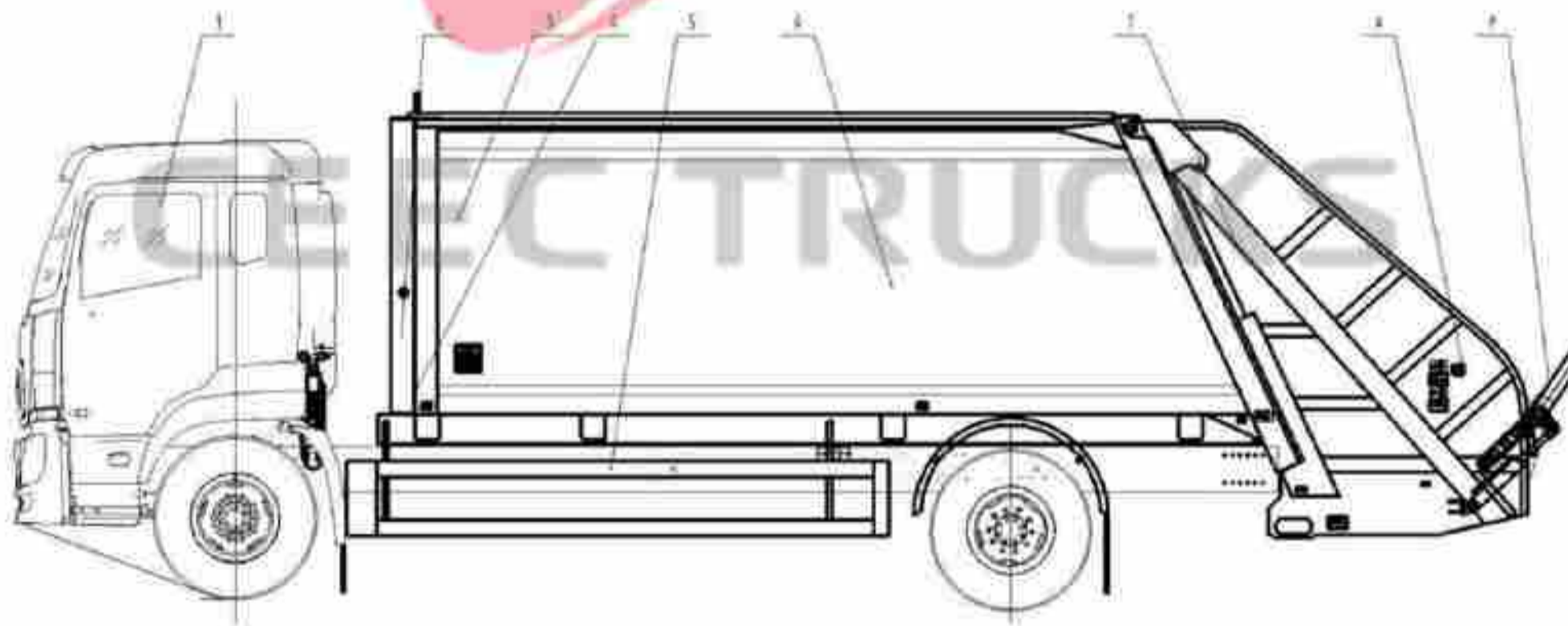

- 1、 Chassis 2、 Hydraulic System 3、 Compactor body 4、 Air Circuit System
5、 Side Safety Fence 6、 Push Shovel 7、 Tailgate 8、 CAN Electric-Pneumatic System
9、 Tilting Device

Above drawing show that there are safety-guards at two sides; at rear of body is tailgate hopper for garbage collection; in front of the tank equipped climbing ladder. Below figure help you better understanding the structure of the garbage truck:

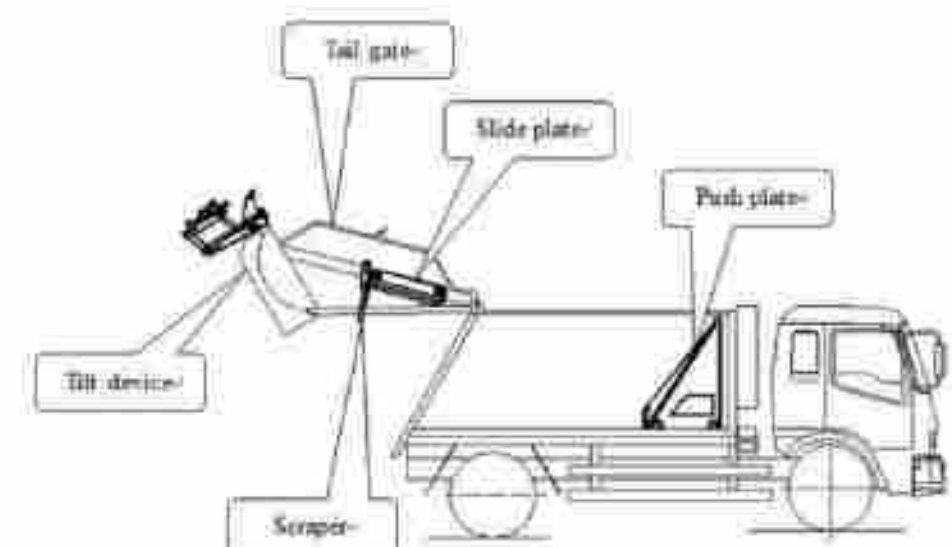

Front View: Hydraulic control system



Each button has three indicators, means as below:
First Indicator: Orange → Waiting for work
Second Indicator: Green → Working ON
Third Indicator: Red → Emergency and need to check system





Electric Control Box
(In tailgate)



Emergency stop Button
(In tailgate)

Hydraulic Control Joysticks
(At drive side)



Front View: garbage collection system and waste water collecting bins



Garbage collection system

Waste water collecting body



Tail Gate Assembly

Slide Plate Assembly





Scraper Assembly



Push Plate Assembly



Tilting Device Assembly

Chapter 4, Garbage Compactor Truck Working Principles

The operator should fully understand Whole Structure and Working Principle for ISUZU Garbage Compactor Truck before any operation. Only trained person can operate this vehicle properly and to prevent unnecessary accidents and equipment damage.

i ,How are the Garbage Compactor trucks working?

The ISUZU Garbage Compactor Truck makes use of the special power take off (PTO) to get power from the engine, and then transfer the power to the Gear Pump so to rotate the pump. The pump start working to transfer hydraulic oil to cylinders through pipelines, and cylinders working to make all garbage trucks equipment working, including tailgate, push plate, slide plate, scraper and tilting device. And then realize all function of the garbage compactor truck.

ii ,What is the main component for truck?

The garbage compactor truck is refitted based on the ISUZU ELF 4x2 chassis. The refit part includes garbage collection assembly, actuator device and operation system.

- *Garbage collection assembly: High Strength steel material tanker body for garbage storage, with tailgate, slide plate, scraper, push plate and tilting device to realize garbage loading and unloading working.*
- *Actuator device: includes power take off, drive line, etc., which can pass the power from the chassis to the gear pump.*
- *Operation system: including CAN Electric control system (Main control box in cabin & Rear control box at side of tailgate) and Hydraulic Joystick control system, this helps come to all special functions' convert.*

iii, **How to operate garbage compactor trucks? (Very Important)**

1.1 Precautions for Truck Usage

2.1 Precautions before use

1. Prepare the truck before departure according to the requirements of the chassis instruction;
2. Check truck lights and ensure that they can work normally;
3. The tailgate should be in the state of falling and lock-up and the push-shovel cylinder should be in the position of maximum extension;
4. The fuel pump should be able to rotate normally after installing the PTO;
5. Since the viscosity of hydraulic oil will increase in low temperature, the operator shall run the compressing-filling and bucket-lifting mechanism in non-loaded condition for several times before loading operation.

2.2 Precaution in use

1. The operation site should be spacious, flat and open;
2. Irrelevant personnel shall never approach the truck, especially the rear during the operation;
3. The garbage should be put into the filling bucket evenly, and no garbage shall be concentrated on one side, which may shift the center of gravity of the truck, or piled too much garbage along the edge of the filling bucket, which may affect the compressing and filling of garbage and lead to uneven distribution of garbage in the garbage can;
4. Attention should be paid to the compressing and filling operation, and in case of any large garbage that are too large to be compressed, the operator shall stop in time, and then continue to work after clearing such garbage, otherwise, the working equipment of the truck may be jeopardized;
5. When lifting and dropping the pre-compressor during the unloading operation, it's necessary to ensure the safety of surroundings, and carry out operation carefully. The pre-compressor shall not be lifted up on the slope; otherwise the center of gravity may easily be shifted backward, thus causing overturning accident;
6. After unloading, the joint surface of the garbage can and the pre-compressor shall be cleaned to ensure that the joint surface is well sealed and avoid damaging the rubber seal due to sharp objects or hard objects in the garbage.
7. The truck shall be allowed to work only after the pre-compressor has fallen down and lock-up.

2.3 Precautions for maintenance after use

1. Do a good job of maintenance according to this instruction and chassis manual in time;
2. The washers at the sewage outlet of blow down apparatus of the garbage can shall be cleaned every day, especially after discharging the sewage, and the residue on the gasket shall be cleaned, otherwise it is easy to cause the damage of the blow down apparatus or the seal failure;
3. Do not spray water directly on electrical components and fuel tanks when washing the truck;
4. No one is allowed to stand or walk under the pre-compressor after it is lifted. It is necessary to hold up the pre-compressor with jack stay and stand up to it with solid supports when lifting up it for maintenance, thus preventing disastrous accidents;
5. During overhaul, no one shall throw, collide, and strike the truck, thus preventing parts from damage, deformation and scratches. When dismantling the hydraulic system, cleaning is necessary;
6. When dismantling the hydraulic system or electrical control system, the pre-compressor should be in the falling position, and the scraper and slider should be put down slowly or fixed, otherwise the any sudden movement of pre-compressor or scraper and slider will damage the equipment or lead to other disastrous accidents;
7. Loading and unloading operations are completed automatically, and no one shall adjust it without permission. When the speed of PTO is too high, PTO or fuel pump power unit will be damaged, and when the speed is too low, the operation efficiency will be affected;
8. The pressure valve spring has been properly adjusted before delivery, and it is strictly forbidden to adjust it without permission. In case of any obvious reduction in loading capacity, it should be repaired at the designated maintenance point;
9. For garbage trucks equipped with external motor as the power system, the opening-closing duration of the scraper is adjusted according to the flow rate of the system. When working via applying the chassis engine, the opening-closing duration of the scraper is shorter than that of the motor power system, and it is normal that the scraper pauses shortly when the scraper opens and closes.

2.4 Cautions for garbage trucks storage

1. The truck should be stored in the garage featured with excellent ventilation, dry and clean environment, free from corrosive medium. In case of open storage, the truck shall be covered with tarpaulin;
2. When the truck is stored, the chassis gearbox should be placed in the neutral position, PTO should be disconnected, and the cylinder should be in a retracted state.

1.2 Ready to work

(If idle for a long time, please keep the truck engine run for a few minutes. Also, should ensure fuel tank and water tank are enough.)

➤ Step 1

Thoroughly check the garbage compactor truck to make sure working environment is good. Then start the truck engine, make sure truck air pressure over 0.6Mpa. Press the Clutch Pedal, meanwhile press the PTO (Power Take Off) to Working Position.



Please Note: Please keep the PTO at Driving Position while driving the truck!
Please does not operating the garbage compactor system while driving the truck!

➤ Step 2

Make sure the working environment is safe. Press the Stop & Start Button 5-6 Seconds to start the electric system, the indicator is green means power ON. Then turn on the button to Loading

NOTE: No staying under Tail Gate

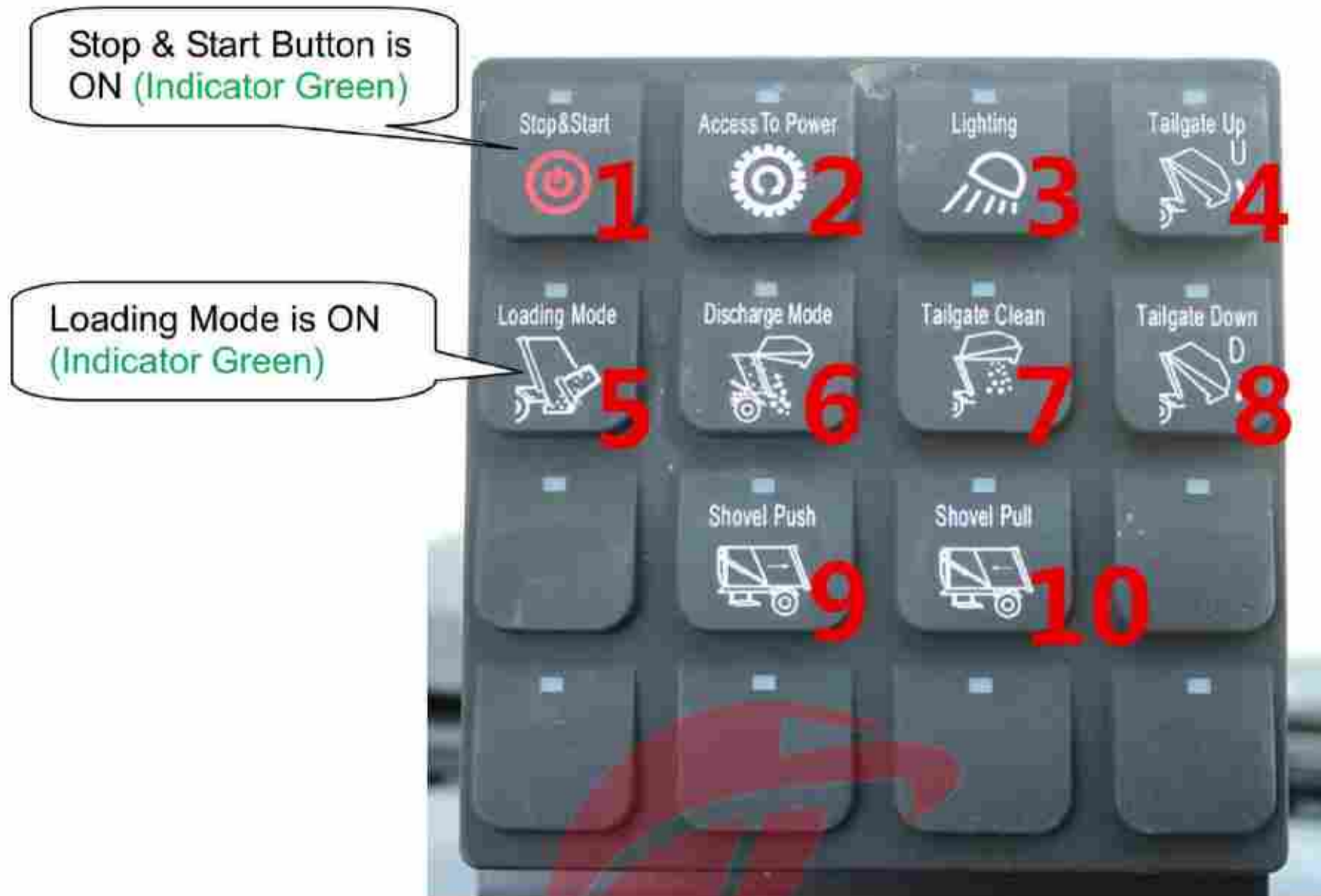

Switch 1: **Stop & Start** (Whole truck electric box working)

Switch 2: **Access to Power**

Switch 3: **Light** (Control LED light in hopper ON / OFF)

Switch 4: **Tailgate Up** (Control Tailgate rising up)

Switch 5: **Loading Mode** (Truck for loading process)

Switch 6: **Discharging Mode** (Truck for discharging process)

Switch 7: **Tailgate Clean** (One cycle working when tailgate lifting up)

Switch 8: **Tailgate Down** (Control Tailgate falling down)

Switch 9: **Shovel (Push Plate) Push** (Push Plate move out to discharge garbage)

Switch 10: **Shovel (Push Plate) Pull** (Push Plate move in and ready for next process)

➤ **Step 3**

Rear Control Box operates instruction.

Kindly refer to below picture to be familiar with the box panel

Automatic operating system & Manual operating system available to you!

The CAN system default is AUTO Mode



Button 1
AUTO Mode: press once, single cycle

Button 2
AUTO Mode: press once, continue cycle

Button 3
MANUAL Mode: press to make scraper open

Button 4
MANUAL Mode: press to make slide plate upward

Button 5
Work Light: for night work

Button 6
MANUAL: press once, change to MANUAL Mode

Button 7
MANUAL Mode: press to make scraper close

Button 8
MANUAL Mode: press to make slide plate down

Button 9
LEFT: tilt device Down
RIGHT: tilt device Up

Button 10
Emergency STOP: press once, stop any process once



Main STOP Button
PUSH IN: stop all process, Button 1~10 not working
PULL OUT: all button 1~10 working

Automatic Operating System

(Default Mode)

Step 3.1.1

Button 9 turn to DOWN, the **tilt device** down, collecting the garbage from 240L bins (2 units 240L garbage bins can be used at same time);

Then turn to UP, the **tilt device** up, the garbage down to the **Tail Gate** hopper. Or just through garbage into the hopper directly.

Turn to DOWN again to make tilt device reposition before the scraper working.

(How does this model garbage compactor truck tilting device working?)



Tilt Device DOWN

Tile Device UP

Step 3.1.2

Press once the Button 1, compression single cycle (**little garbage at Hopper**)

Press once the Button 2, compression continue cycle (**much garbage at Hopper**)

Step 3.1.3

Press once the Button 10, when continue cycle compression finished.

NOTE: Press the Button 10 or Main STOP Button when there is an emergency!

Step 3.1.4

Make the **tilt device** STOP, the truck is ready for next compression work.

Manual operating system

Press once Button 6 turn to MANUAL Mode

Step 3.2.1

Button 9 turn to DOWN, the **tilt device** down, collecting the garbage from 240L bins (2 units 240L garbage bins can be used at same time);

Then turn to UP, the **tilt device** up, the garbage down to the **Tail Gate** hopper. Or just through garbage into the hopper directly.

Turn to DOWN again make tilt device reposition before the scraper working.

Step 3.2.2

Press the Button 3 to make **Scraper** open

Press the Button 8 to make **slide plate** down.



Step 3.2.3

Press the Button 7 to make the **scraper** closed to collect garbage.

Step 3.2.4

Press the Button 4 to make the **slide plate** upward.

Step 3.2.5

Press the Button 3 to make the **scraper** open again.

Step 3.2.6

Operate once again to collect and compress more garbage.

(**NOTE:** **tilt device** should be **STOP** every time before the scraper working)

➤ **Step 4**

NOTE: Only suggest to use MANUAL JOYSTICK when maintenance or emergency!

(Operation Joysticks with English version plate for operating guidance)

Control the **manual joystick** to work.

Joystick1: Shovel
Control the Push Plate **Out & In**

Joystick2: Sliding Plate
Control the slide plate **Down & Up**

Joystick3: Scraper
Control the scraper **Off & On**

Joystick4: Lifting
Control the tail gate **Up & Down**

Joystick5: Rolling Over (Not Included)
Control the Tilting Device **Rise & Down**



Pressure Gauge

1.3 Dumping the garbage

➤ Step 1

Make sure **no staying under the Tail gate**
(Please be sure for every compression work)

➤ Step 2

Turn the main control to Unload

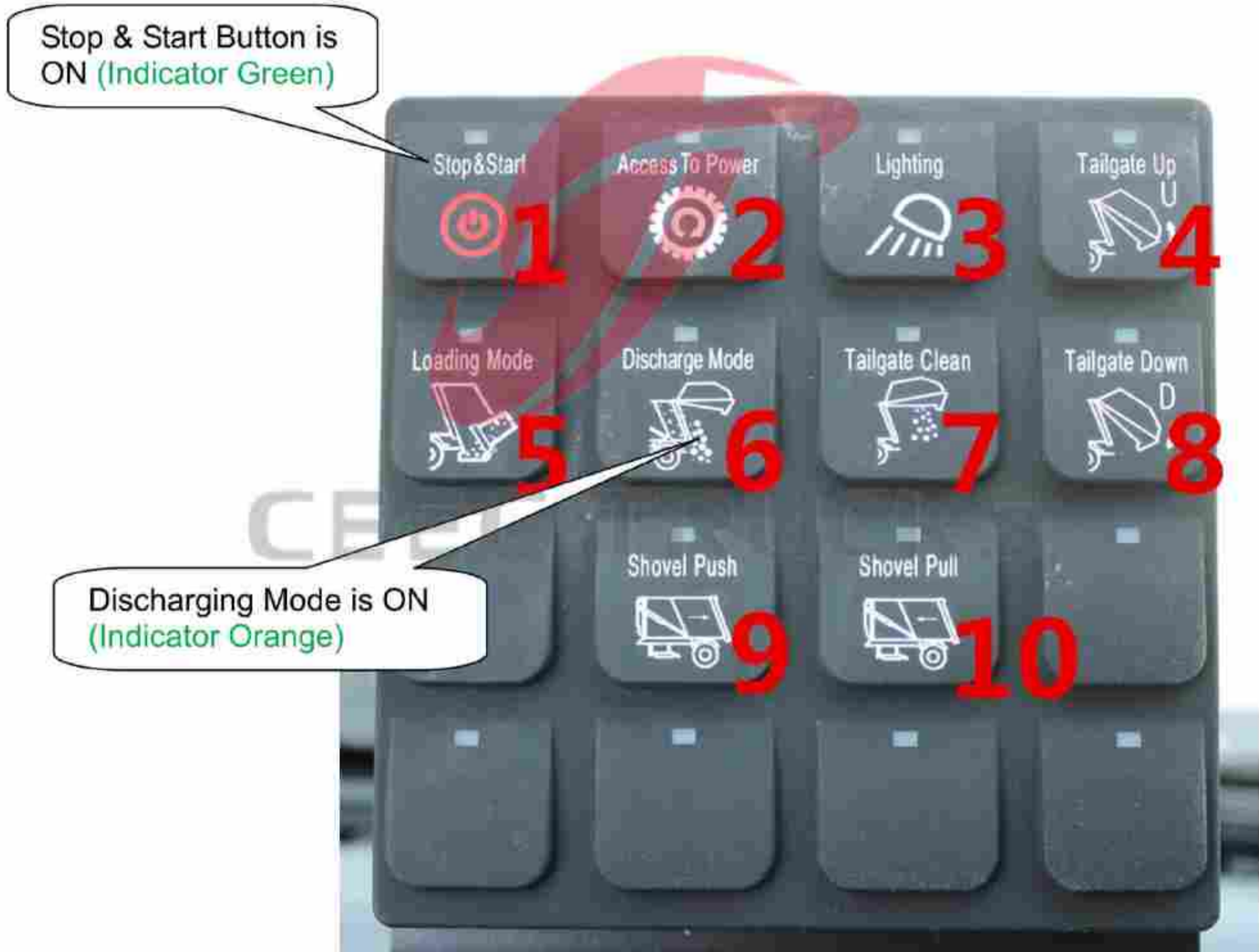

➤ Step 3

Press Button 4 or Control Joystick 4 to make the **tail gate up**.



Press Button 4 or Control Joystick 4 to make the **tail gate** up.

Press Button 9 or Control Joystick 1 to make the **push plate** move out.

➤ **Step 4**

Press Button 9 or Control Joystick 1 to make the **push plate** move out.

➤ **Step 5**

Press Button 7 to make single cycle working and discharge the garbage inside of tailgate. Wait until all garbage discharged

➤ **Step 6**

Press Button 10 or Control Joystick 1 to make the **push plate** move in until reposition.

➤ **Step 7**

Press Button 8 or Control Joystick 4 to make the **tail gate** down. Please reposition all when **tail gate** down completely.

➤ **Step 8**

Drain out all the waste water produced by compressing work. (Press Button 5 if necessary)



Waste Water Vents
(Below the Tailgate)



Waste Water
collection tank

1.4 Cleaning the body

The engine must **flameout** when arrive at cleaning field.

Clean vehicle exterior.

Press Button 4 or Control Joystick 4 to make the **tail gate up**. Then cleaning the inside body.

Clean the **tail gate device** internal. Add some lubrication on spindle to keep compactor work safety and smooth.

Garbage Compactor Truck Hydraulic Drawing:

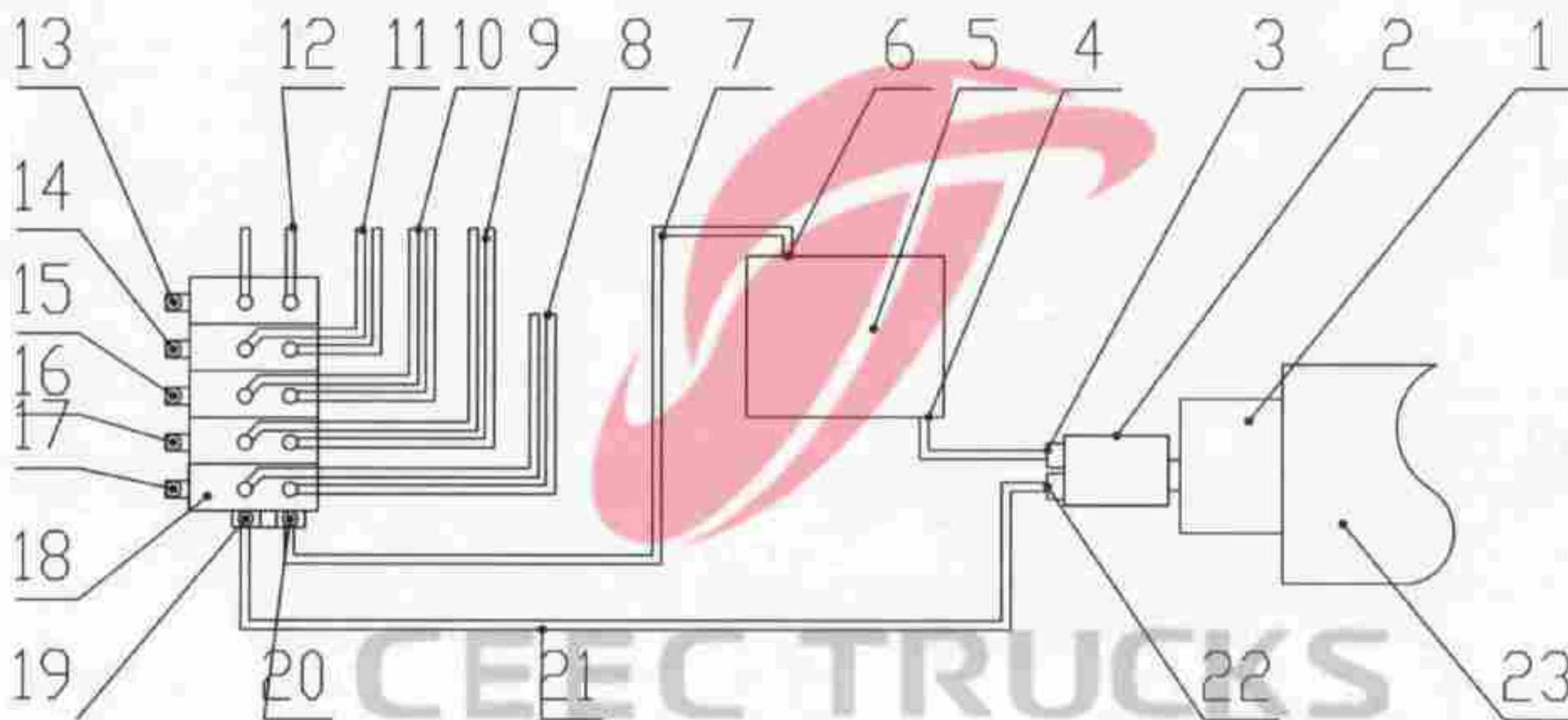

- | | | | | |
|-----------------------------------|------------------------------|----------------------------|------------------------------------|---------------------|
| 1, PTO | 8, Push Plate Oil Cylinder | 13, Joystick 5 for Item 12 | 18, Multi-way Valve | 23, Chassis Gearbox |
| 2, Oil Pump | 9, Slide Plate Oil Cylinder | 14, Joystick 4 for Item 11 | 19, Oil Inlet for Multi-way Valve | |
| 3, Inlet Pipe for Oil Pump | 10, Scraper Oil Cylinder | 15, Joystick 3 for Item 10 | 20, Oil Outlet for Multi-way Valve | |
| 4, Outlet pipe for Oil Tank | 11, Tail Gate Oil Cylinder | 16, Joystick 2 for Item 9 | 21, Oil Pipeline | |
| 5, Hydraulic Oil Tank | 12, Tilt Device Oil Cylinder | 17, Joystick 1 for Item 8 | 22, Oil Inlet for Oil Pump | |
| 6, Inlet Pipe for Multi-way Valve | | | | |
| 7, Oil Pipeline | | | | |

Hydraulic Oil change suggestion: **YWZ-80T hydraulic oil or standard hydraulic oil**

For First Time: After 150-hour working, please change the hydraulic oil;

For Second Time: After half year working, please change the hydraulic oil;

Form Third Time: After every year working, please remember to change the hydraulic oil.

Chapter 5, Maintenance and Repair Instruction

Maintenance and Repair Instructions

The routine maintenance requirements and procedures for each subsystem of the compactor are described.

Every day

1. Before maintenance work, the following things should be done firstly:

- a. Turn off the PTO(power take-off) and speed-up switch, turn the manual joysticks to middle level.
- b. Flameout the engine, take the key and put it into your pocket or other place to make sure it's safe.
- c. Use the parking brake.
- d. Put a sign wrote "under maintenance, please do not start" on the steering wheel.
- e. Put chock under the wheels to make truck stability.

2. Cleaning vehicle exterior, the inside and outside of the tilt device, the oil tank and pipe, all these daily working has purpose to prevent rust and to keep compactor ready for work anytime.

3. Carefully examine the hydraulic system, including whether hydraulic oil at normal level, whether the hydraulic pipeline leak oil or not, which can protect the compactor truck and always keep the compactor ready to work anytime.

4. Carefully check whether the electric system work normal or not, including the tail lights, the work indicating lamp etc.

5. Carefully clean the compress lock at the rear of the truck. To keep compression work efficiently.

6. Carefully check the entire compactor to inspect whether any warning signs and operating instruction sign fell off. Catch up on them when necessary.

7、 Lubricate the whole pathway of the compressed garbage truck every day.

8、 Carefully clean the **push plate** and surrounding of the oil tank.

Every week

1、 Carefully inject butter or other lubrication to the spindles of the compactor, places are as below pictures:

- a、 Lubricate the spindles of the tail gate
- b、 Lubricate the cover of pivots of the scraper
- c、 Lubricate the oil cylinder bearing of the scraper
- d、 Lubricate the pathway of the slide plate
- e、 Lubricate the all the connecting rod
- f、 Lubricate the chassis by following the maintenance manual



2、 Carefully exam the compactor to check out whether any connection place need to fasten again.

Every month

1、 Carefully exam all the pipes, find out whether there is any leakage. If there are, please exchange it immediately.

- 2、 Carefully exam the compression cylinder and the scraper oil cylinder piston rod, find out whether they are all working normally.
- 3、 Carefully exam the push plate oil cylinder, find out whether it work normally.
- 4、 Carefully lubricate axles of the push plate to make it work smoothly and efficiently.
- 5、 Carefully lubricate the sideways of the push plate to make it work normally.

Every 6 month

- 1、 Carefully cleaning the air filter.
- 2、 Carefully cleaning the oil suction filter.
- 3、 Carefully replace the oil filter cartridge
- 4、 Carefully exam the entire body of the truck to find out if anything need improved. Such as any place rusting; is the framework still work normally etc.

CEEC TRUCKS

Every 2 Year

- 1、 Cycle maintenance as mentioned above.
- 2、 Carefully clean fuel tank, replace the hydraulic oil.

Maintenance of the hydraulic system

1. Hydraulic oil tank

- a. Fine filter of oil return pipe: First exchange happened after 50 hours use, then every 250hours. When there is something wrong with the main parts of the hydraulic system also should change it.
- b. Respirator: Keep the respirator clean, non-stop and correctly installed to make the air can goes inside the oil tank freely. Exchange the respirator every 6 month. (the exchange time should be short when working at dirty environment for a long time.)
- c. Hydraulic oil: First exchange happened after 150 hours use,
Second exchange happened after 6 month use,
Then every 12 months use.

NOTE: YWZ-80T hydraulic oil or standard hydraulic oil;

- d. Oil outlet strainer: Should be cleaned every time exchange the oil. Replace it when necessary.

2. Oil cylinder

- a. Carefully exam the oil cylinder to find out whether there is leakage and noise or not every week.
- b. Carefully check the oil tank, repair when there are scar on piston rod, repair all the scars in time to avoid any danger.

Tightening torque of bolts

Bolted joints	Thread specifications	Tightening torque (N.m)
A bolt connecting the connecting base, wheel cover, lamp holder, box to chassis, and connecting bolts of transmission shaft.	M10	50-70
	M12	100-120
	M14	140-180
	M16	210-280
	M20	350-450

Note: The tightening torque of chassis bolt is shown in the manual of the corresponding chassis

Chapter 6, Troubleshooting

Failure	Cause	Solution
Oil leakage happened on oil cylinder piston rod	<ol style="list-style-type: none"> 1、 The damage of the sealing ring 2、 There are scars on the surface of the piston rod 	<ol style="list-style-type: none"> 1、 Carefully exam the guide sleeve and replace the sealing ring 2、 Replace the parts.
Piston rod move slowly	<ol style="list-style-type: none"> 1、 Some air mixed in the hydraulic cylinder or in the hydraulic oil 2、 There are no hydraulic oil in the tank or oil level is too low to work normally. 3、 Viscosity of hydraulic oil failing standard 4、 Stoppage of the oil inlet/outlet strainer 5、 Stoppage or limiting of the hydraulic oil in system 6、 Leakage of the oil suction pipe 7、 Abrasion of the oil pump 8、 Abrasion of some parts 9、 Adjustment of the parts are not proper. 10、 Pressure valve is too dirty 11、 Overload of the system work 	<ol style="list-style-type: none"> 1、 Eliminate all the air 2、 Inject some hydraulic oil and carefully check the system. 3、 Replace hydraulic oil to recommended ones. 4、 Carefully clean or replace it, and find out the polluted reason 5、 Carefully check the oil pipes and clean them. 6、 Repair or replace it 7、 Repair or replace it 8、 Carefully check the pump, valve and oil cylinder, find the abrasion part and repair or replace it. 9、 Refer to the technical manual to adjust properly 10、 Carefully clean it 11、 Refer to the technical manual to load properly. 12、 Reconnect the oil pipe properly

	<p>12、 Improper oil pipe connection</p> <p>13、 Oil pump not work</p> <p>14、 The hydraulic oil temperature is too low</p> <p>15、 The engine's revolving speed is not enough</p>	<p>13、 Carefully check the PTO</p> <p>14、 The viscosity is too high and should be adjust oil temperature to working level</p> <p>15、 Adjust to proper level</p>
Hydraulic cylinder pushing is powerless	<p>1、 Damage of the piston sealing</p> <p>2、 System pressures is too low (the overflow valve became imbalance)</p> <p>3、 Damage of the oil pump, System pressures is too low</p> <p>4、 Shortage of the hydraulic oil</p> <p>5、 Stoppage of the oil filter</p>	<p>1、 Carefully exam and replace the sealing element</p> <p>2、 Carefully exam and adjust the pressure of the overflow valve</p> <p>3、 Carefully exam and replace the oil pump</p> <p>4、 Carefully exam and fulfill the hydraulic oil</p> <p>5、 Carefully exam and replace the filter element</p>
Leakage of the oil pump	<p>1、 Damage of the sealing filter</p> <p>2、 The oil pipes are not sealed as required</p>	<p>1、 Carefully exam and replace the sealing ring</p> <p>2.1、 Carefully exam, tighten the joint</p> <p>2.2、 Replace the joint or add some sealant to seal the joint</p>

<p>Blister exist in the hydraulic oil</p>	<ol style="list-style-type: none"> 1、 Oil level in the tank is too low 2、 There is water in the hydraulic oil 3、 Leakage of the pipe between the oil tank and the pump 4、 Hydraulic hose is kinked or squished, and limit the flow of the oil 5、 Have not choose the right hydraulic oil 6、 Abrasion of the sealing parts in oil pump axle 	<ol style="list-style-type: none"> 1、 Adjust the oil to required level. Carefully exam the leakage of the system. 2、 Exchange new hydraulic oil 3、 Fasten the joint or exchange suction pipe 4、 Replace the oil pipe 5、 Exchange to the recommend oil 6、 Carefully clean or replace it.
<p>Oil pump is too noise while working</p>	<ol style="list-style-type: none"> 1、 The hydraulic oil viscosity is too high 2、 Speed of the oil pump is too high 3、 Suction pipe is blocked or extrusion 4、 The oil tank's respirator is blocked 5、 Primary oil filter is blocked 6、 Parts sticking to each other 7、 There are air in the hydraulic oil 8、 Hydraulic oil level is too low 9、 Parts of the oil pump is abrasion 	<ol style="list-style-type: none"> 1、 Change low viscosity oil 2、 Adjust the oil pump's speed to required level. 3、 Cleaning or exchange the suction pipe 4、 Open the respirator , Carefully wash to clean it. 5、 Cleaning the filter screen 6、 Carefully repair the sticking parts, cleaning all of them, and replace when necessary 7、 Carefully check the system, replace the suction pipe and sealing parts. 8、 Adjust to proper level 9、 Repair the oil pump and find out the reason

Leakage of oil cylinder	<ol style="list-style-type: none"> 1、 Damage of the cylinder 2、 Damage of the parts of piston valve 3、 Parts of the oil cylinder is loose 4、 Damage of the piston rod 	<ol style="list-style-type: none"> 1、 Replace the cylinder and find out why it damaged 2、 repair or replace the piston valve, find out the reason 3、 Fasten the parts until no leakage 4、 Carefully exam, exchange it when necessary
Hydraulic oil temperature is too high	<ol style="list-style-type: none"> 1、 Use the control valve for a long time 2、 Hydraulic oil is not proper 3、 The revolving speed is high 4、 The inside leakage 	<ol style="list-style-type: none"> 1、 The manual joystick should reposition when not use 2、 Exchange to proper oil 3、 Adjust to proper level 4、 Carefully check the pump, valve and oil cylinder to find out reason, then repair it.

Attention

- 1、 Please refer to the chassis manual for chassis faults and troubleshooting.
- 2、 Users shall not adjust the pressure of hydraulic system by themselves, otherwise the hydraulic system no longer enjoy warranty services of repair, replacement and refund, and users will have to bear all consequences in case of any faults in the whole truck.
- 3、 Since the hydraulic system is a high-pressure system, when overhauling fuel pumps, multi-channel valves, solenoid valves and other hydraulic components, as well as pipeline and cylinder mentioned in Table 7-1, please contact our Company professionals, and the above troubleshooting methods are only for reference.
- 4、 The safety valve has been adjusted properly before delivery, and it shall not be adjusted without permission.

Appendix A: Schematic Diagram of Hydraulic System

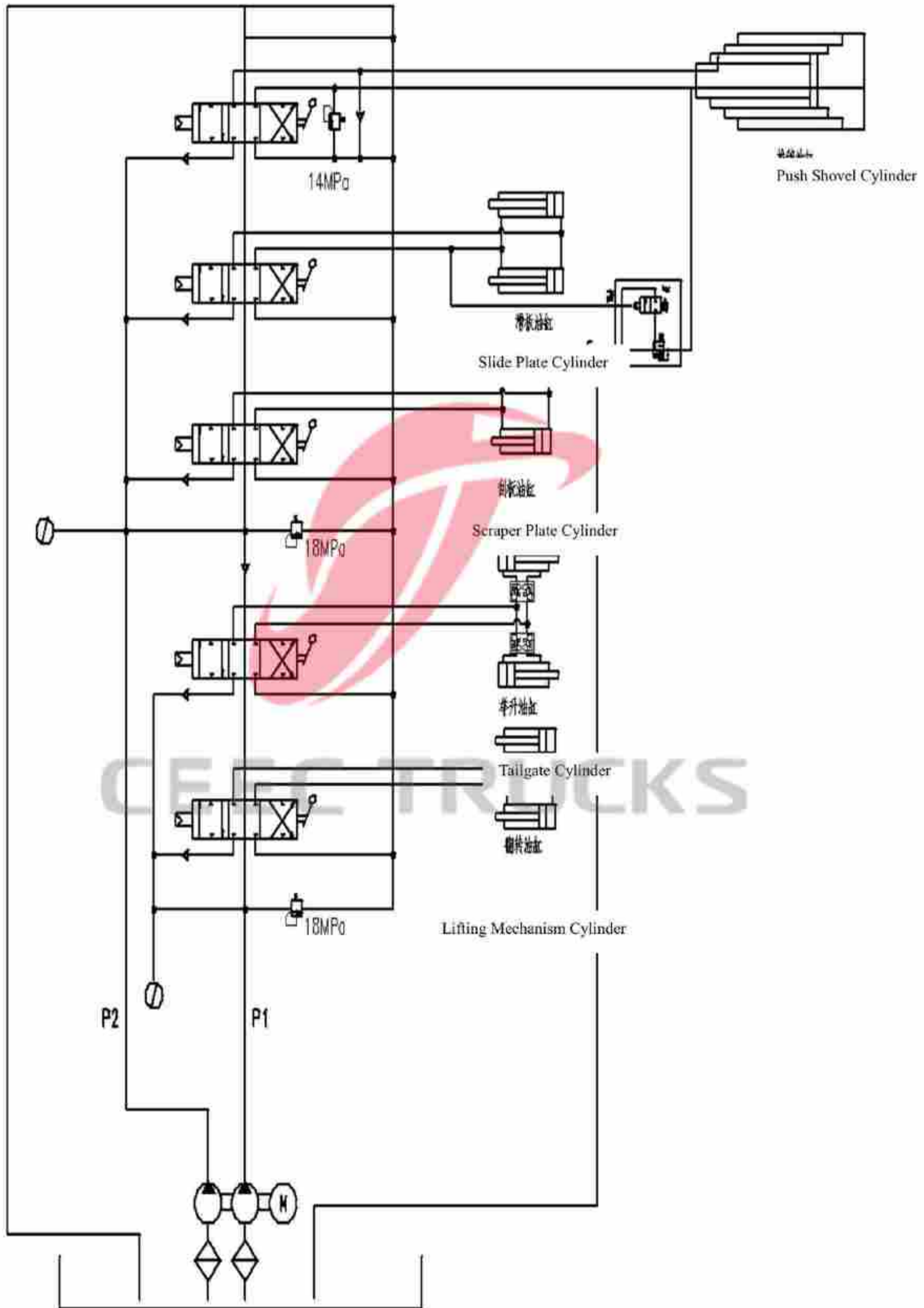

Appendix B: Schematic Diagram of Electrical System Con

